

Notice de montage Work Wall

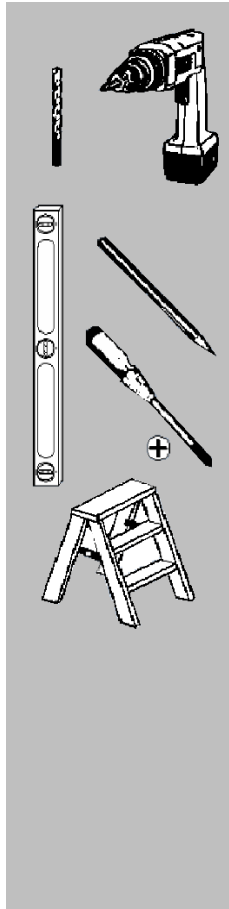

Profils horizontaux

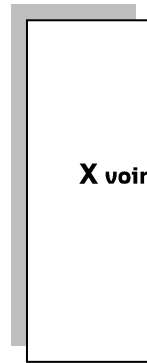
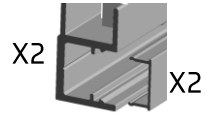

Profils verticaux

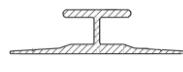
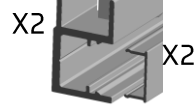

Profil de jonction
X voir format

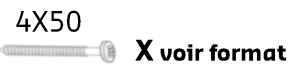
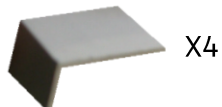

ATTENTION : L'assemblage et l'installation de ce produit doivent respecter les instructions ci-jointes et être effectués par une personne compétente. Cette personne devra contrôler que le mur est adapté à la pose et que les éléments de fixation supportent les efforts générés.



EN14864

EN14434

1

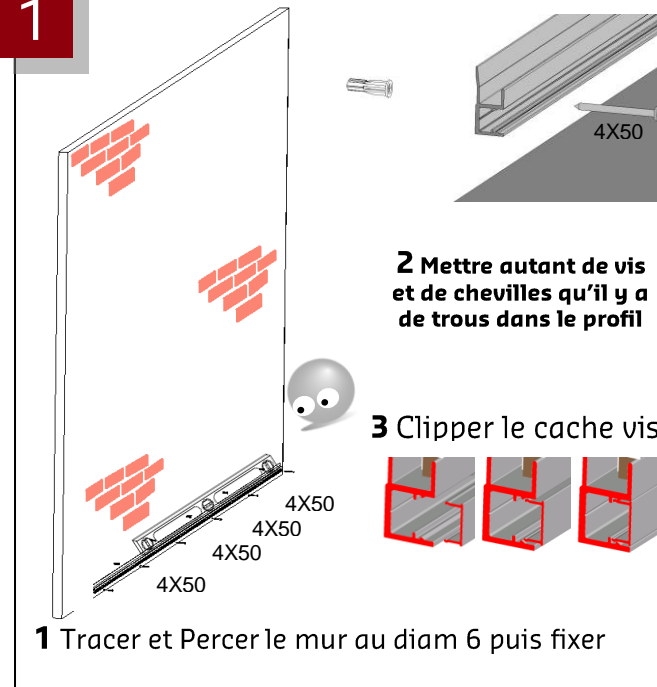

2

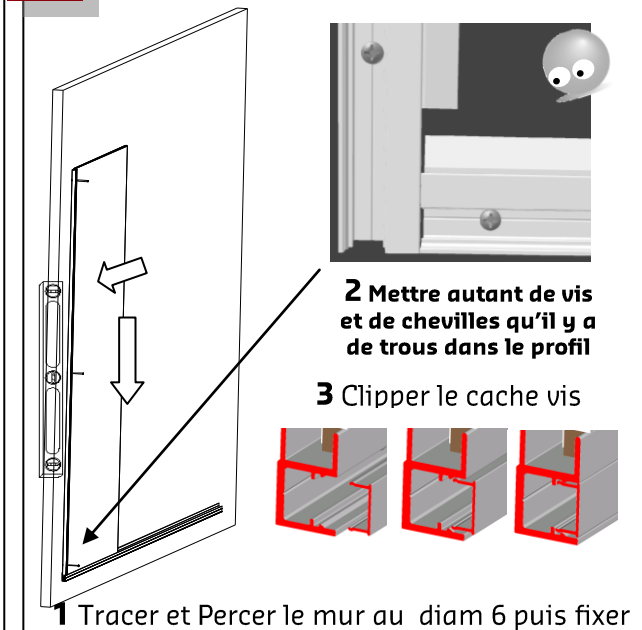

4

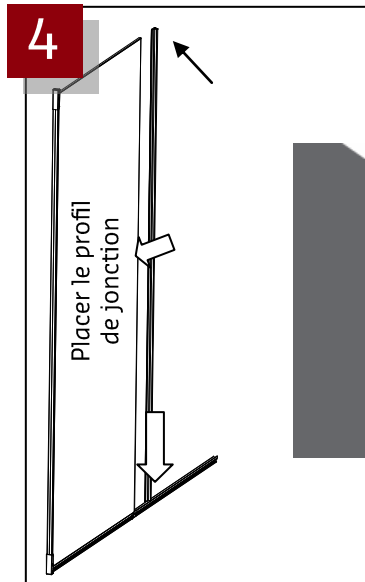

5

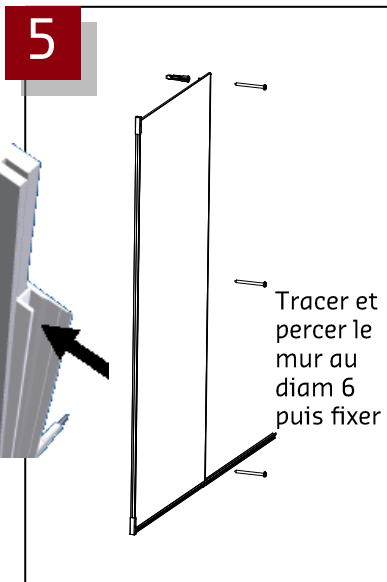

6

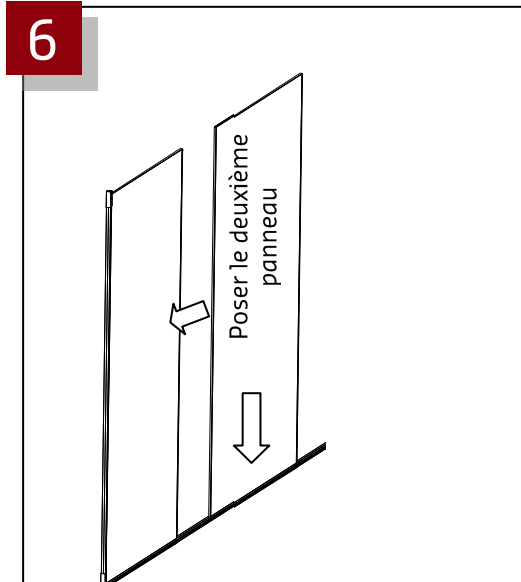

Notice de montage Work Wall

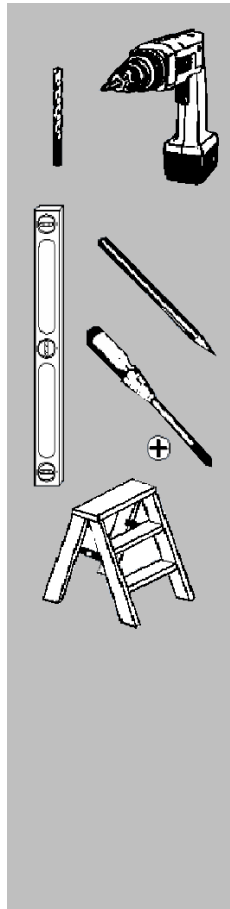

7

Placer le profil de jonction

8

Tracer et percer le mur au diam 6 puis fixer

9

Poser le troisième panneau

10

Tracer et percer le mur au diam 6 puis fixer

11

Tracer et percer le mur au diam 6 puis fixer.

*Mettre autant de vis et de chevilles qu'il y a de trous dans le profil

2 Clipper le cache vis

3 visser les caches aux 4 coins